

## 10. Use via mobile APP and remote control for wireless control.

- 1). Press the <Menu> key and rotate the knob to select Bluetooth [ \* ], press the knob to select <on> to turn on Bluetooth; and open the mobile APP to automatically connect to the video light to realize wireless control.
- 2). 2.4G wireless control mode can be selected to turn on or off.
- 3). The APP can be downloaded from the YONGNUO official website or scanning the QR code on the gift box.

The functions in this manual are based on the test conditions our company.

Further notice will not be given if the design and specifications change.



APP Download



YONGNUO Web

# YONGNUO

## YNRAY100

Pro LED Video Light



## **Introduction**

Thank you for using YONGNUO products!

Please read this manual carefully before using the product and keep it properly for future reference.

## **Precautions**

1. Please keep product away from children, do not place it in the children's activity area.
2. Please use this product under supervision, and power off when unsupervised.
3. Before use, please check whether the power voltage fits the voltage marked on the product.
4. It is recommended to use the original cables or accessories provided or sold by YONGNUO.
5. When the power cord is connected, please place it properly to avoid tripping people or blackout, and do not place it on the hot or damp surface.
6. When the product runs, please do not cover the dissipation hole to avoid product damage due to poor dissipation performance.
7. When the product runs, do not look straight at the lamp beads to avoid eyes discomfort due to strong lights.
8. When the product runs, lamp beads are at the heating state, do not touch it to avoid burning.
9. When high-temperature warning occurs, please check whether the fan is faulty.
10. Use this product in dry environment. This product is not waterproof or fireproof. Do not use it in hot, rainy, damp or dusty environment.
11. Do not use this product near chemicals, flammable gases, inflammables and explosives.

12. Before storing the product, please turn off the power, unplug the power cord, wait for the product to cool down completely, and store it in a portable bag or a dry environment.
13. Please do not use the damaged power cord or the cracked product caused by falling off.
14. This product is not fall-proof, please use it carefully to avoid falling down or getting heavy hit.
15. Before cleaning the product, please ensure that the power is turned off, and please use a dry soft cloth for cleaning.
16. Please do not disassemble the product by yourself. In case of failure, problems shall be handled by the company or authorized maintenance personnel.

## Product specification

Light Source	One COB lamp bead
Color temperature version	Single color temperature version: 5600K; Bi-color temperature version: 2700K-6500K
Output power	Constant power 120W (Color temperature changes with power unchanged)
External power source	DC 19V $\overline{\text{---}}$ 6.31A、Interface size, $\varnothing 5.5 \times 2.1 \text{mm}$ 
APP Bluetooth control	$\leq 50\text{m}$
2.4G wireless control	$\leq 100\text{m}$
Luminance Angle	110°
Product Net Size	25.2*13.7*31.4CM
Average Service Life	50000H

## Check list

### Single light version

Package Dimensions: 33\*32\*18.5CM.

Contents: Video light (1), User Manual (1).

### Kit version

Package Dimensions: 51\*22\*38CM.

Contents: Video light (1), Power adapter (1), power line (1), Standard Reflector (1), Portable case (1), User Manual (1).

Note: Please contact your dealer if anything missing.

## Photometrics

Bi-color temperature version	illumination Distance	Single light	(Official accessory) Standard Reflector	Dragon-scale Armor
2700k	1m	4600lux	18600lux	51498lux
	2m	1100lux	3750lux	10900lux
	3m	500lux	1570lux	4500lux
Bi-color temperature version	illumination Distance	Single light	(Official accessory) Standard Reflector	Dragon-scale Armor
5600k	1m	5622lux	23900lux	64565lux
	2m	1300lux	4780lux	13700lux
	3m	600lux	2040lux	5600lux
Bi-color temperature version	illumination Distance	Single light	(Official accessory) Standard Reflector	Dragon-scale Armor
6500k	1m	5488lux	23200lux	62162lux
	2m	1300lux	4750lux	13300lux
	3m	600lux	2010lux	5400lux
Single color temperature version	illumination Distance	Single light	(Official accessory) Standard Reflector	Dragon-scale Armor
5600k	1m	5680lux	26500lux	45000lux
	2m	1510lux	5210lux	8260lux
	3m	832lux	2200lux	3270lux

\* This is an averaged result, the number might be slightly different on each light.

## Product structure

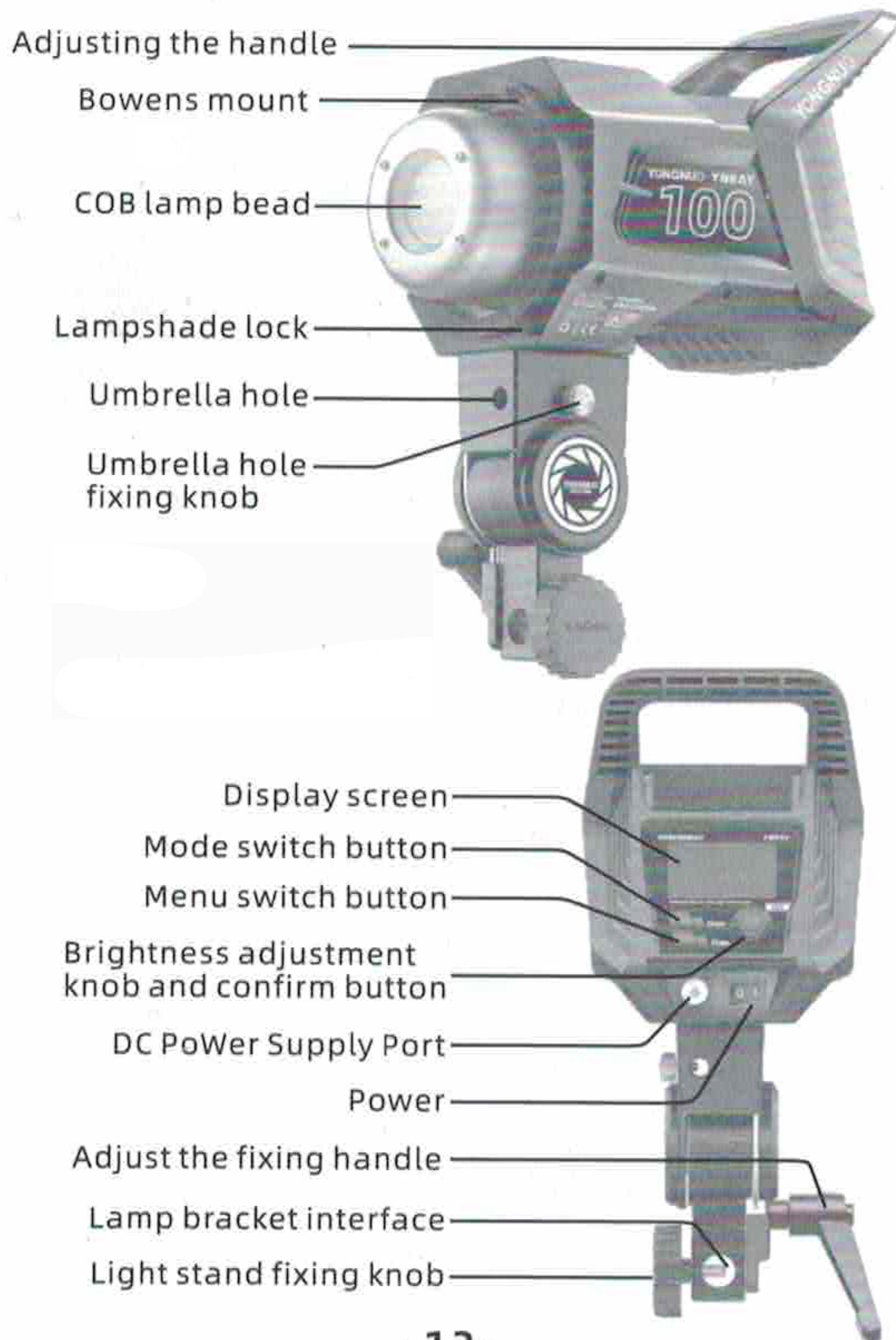

-13-

## Installation and use

### 1. Powered by power adapter:

When the voltage is in the range of 19-26V, the maximum power is 120w;  
When the voltage is in the range of 14~18V, the maximum power is 60w.

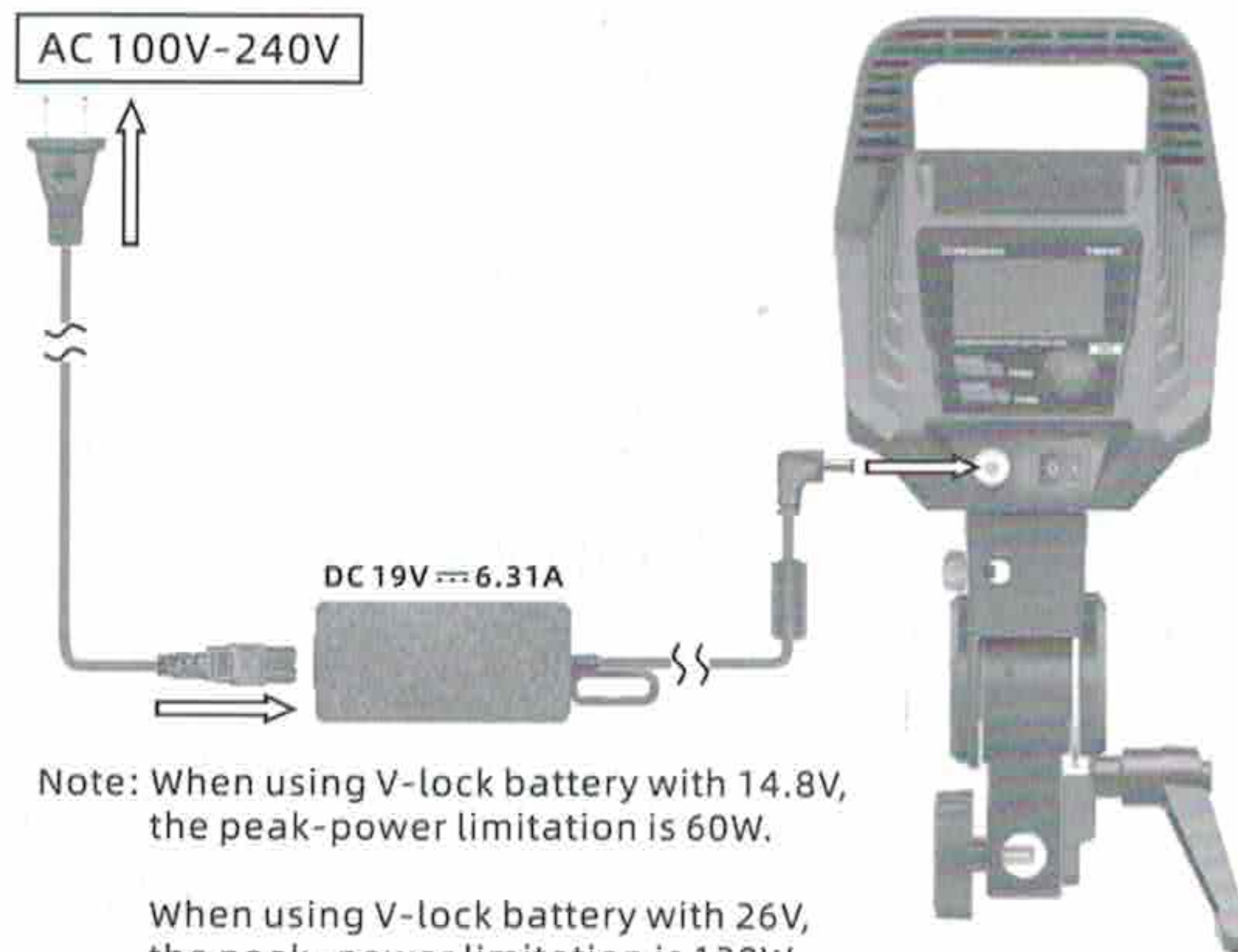

### 2. Power ON or OFF.



-14-

### 3. Color Temperature Setting.

Press the knob to switch color temperature and brightness, and rotate the knob to adjust the parameters.

(Color temperature is adjusted accurately to 50K.)

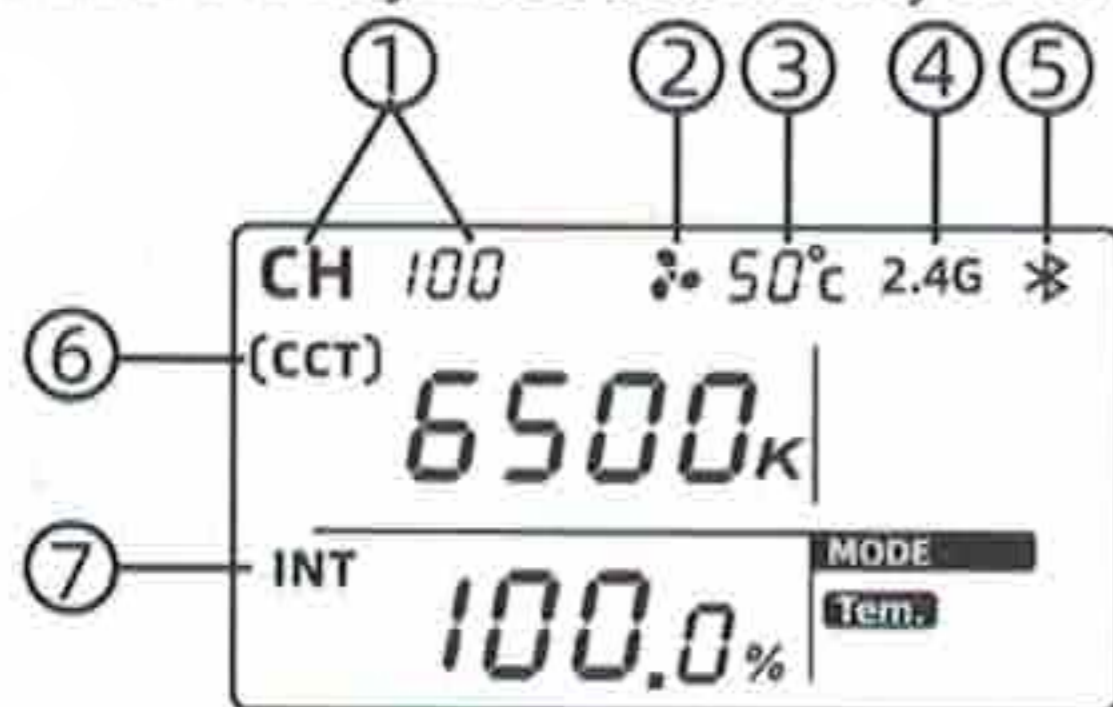

1. Channel Display.
2. Fan(Switch Display).
3. Lamp Bead Temperature Display.
4. 2.4G(Switch Display).
5. Bluetooth (Connection Display)
6. Color Temperature Display.
7. Brightness Display.

### 4.4 kinds of professional-grade dimming curve models settings.

Press the button <Menu>, rotate the knob until **M** blinks, press the button to stop blinking, rotate the knob to choose dimming curve model and press the knob to confirm.

(Note: After the menu is set, press the <Menu> key to return; It will return automatically after about 7 seconds without operation.)

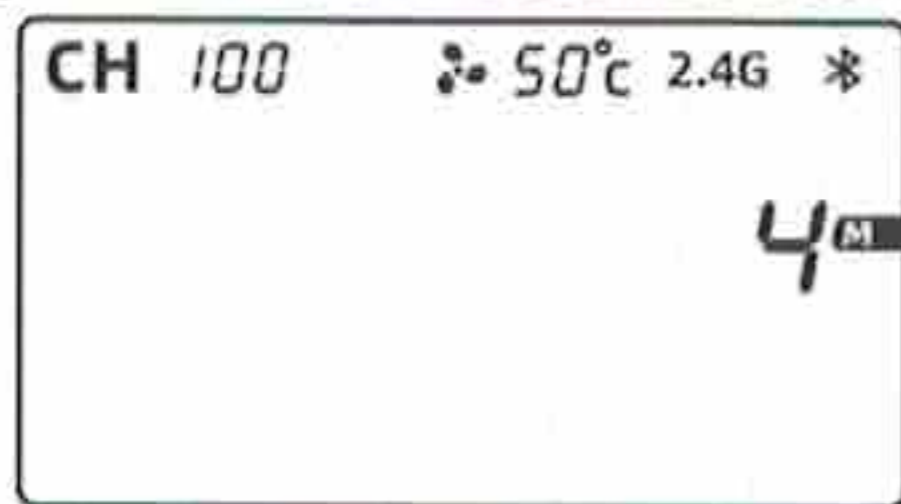

-   
 1 Exponential
-   
 2 Logarithmic
-   
 3 S-shaped
-   
 4 Linear

### 5. Channel Setting.

Press the <Menu> key, select the channel [CH], then press the knob to confirm, rotate the knob to adjust the channel then press the knob to confirm the channel.

(Note: CH1-CH8 channels are compatible with YONGNUO's early video light products, we recommend to use channels above CH9 for a smoother control experience.)

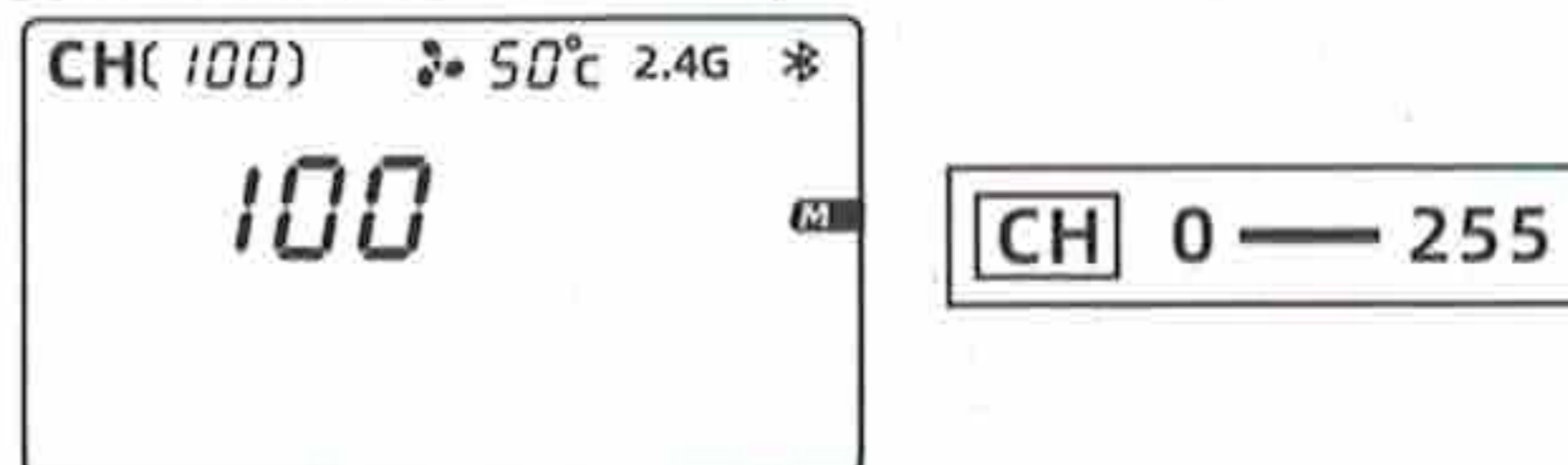

### 6. Effects Setting.

Press the <Mode> key to enter the special effect mode, press the knob to switch and select the special effect mode, speed and brightness, and rotate the knob to adjust the parameters; press the <Mode> key to return to the color temperature mode.

(Note: 9 special modes for white version.)

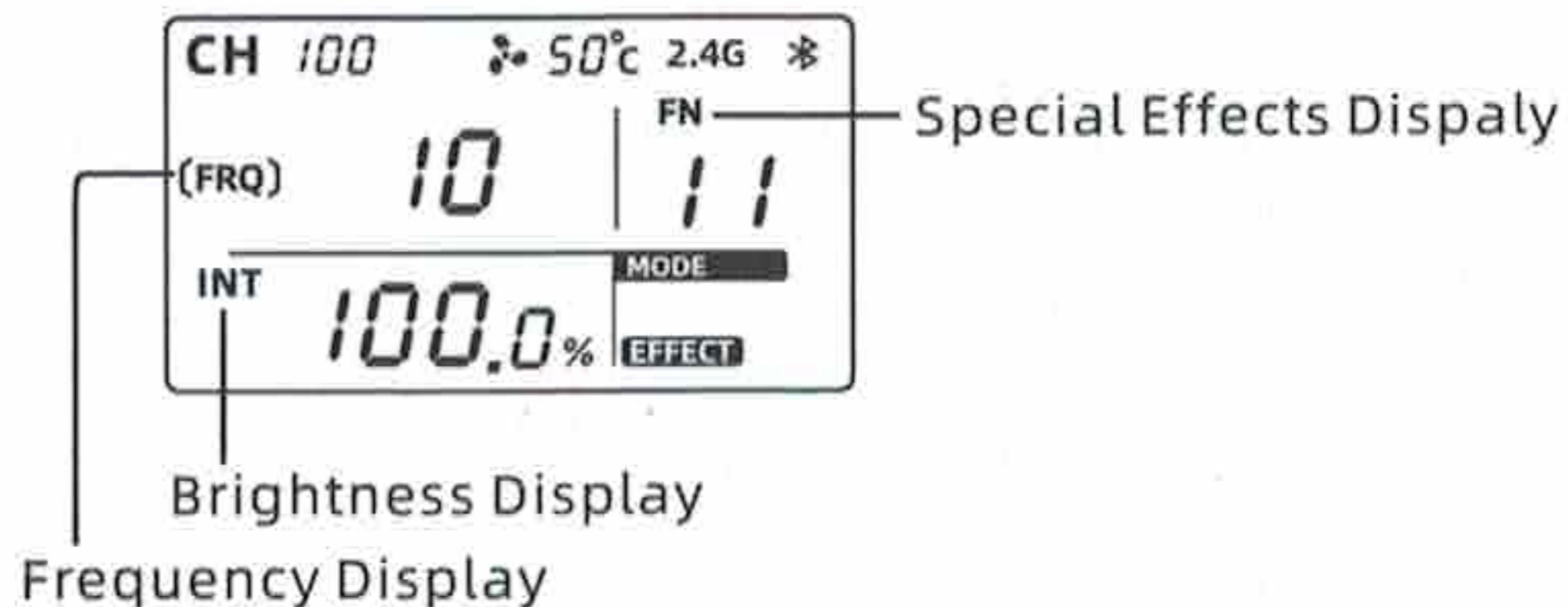

-   
 0 Simulated lightning
-   
 1 Film screen reflection
-   
 2 Paparazzi
-   
 3 Strobe
-   
 4 SOS
-   
 5 White breathing light



## 7. Multiple lights layout mode setting.

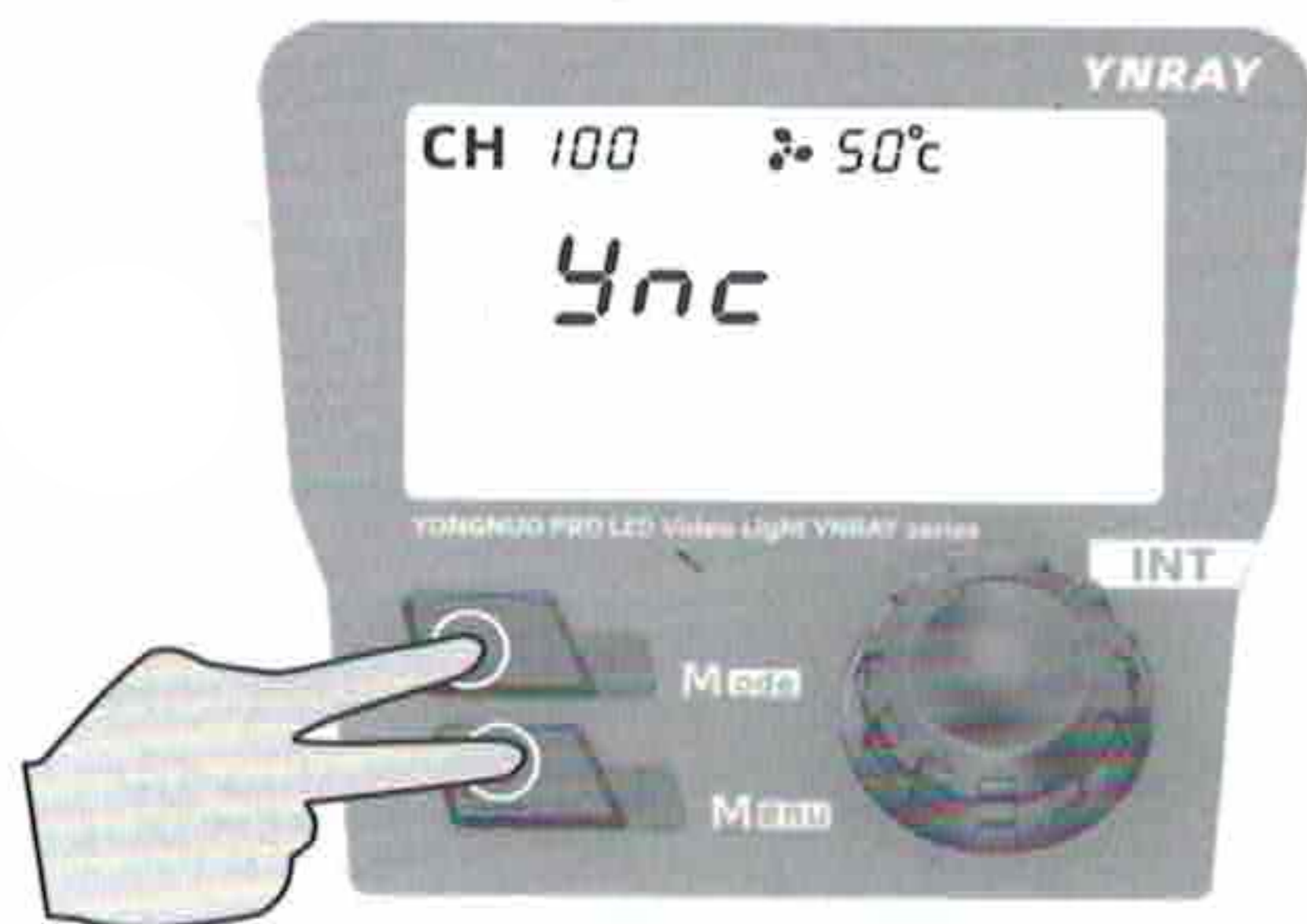

1. Enter the layout mode: Press **<Mode>** and **<Menu>** keys simultaneously for 3 seconds to enter the mode.
2. Switching channels in layout mode: Press the **<Menu>** key, select the channel **[CH]**, then press the knob to confirm, rotate the knob to adjust the channel then press the knob to confirm the channel.
3. To exit the layout mode: **<ync>** is displayed on the screen interface, press the **<Mode>** key to exit.

Please download APP for using layout mode.

## 8. Fan setting.

Press the **<Menu>** key, rotate the knob to select the fan **[ ]**, press the knob to select **<on>** to turn on or **<off>** to turn off the fan.

**on:** The power is 120W when the fan is on.

**off:** The power is reduced to 20 Watts when the fan is off.

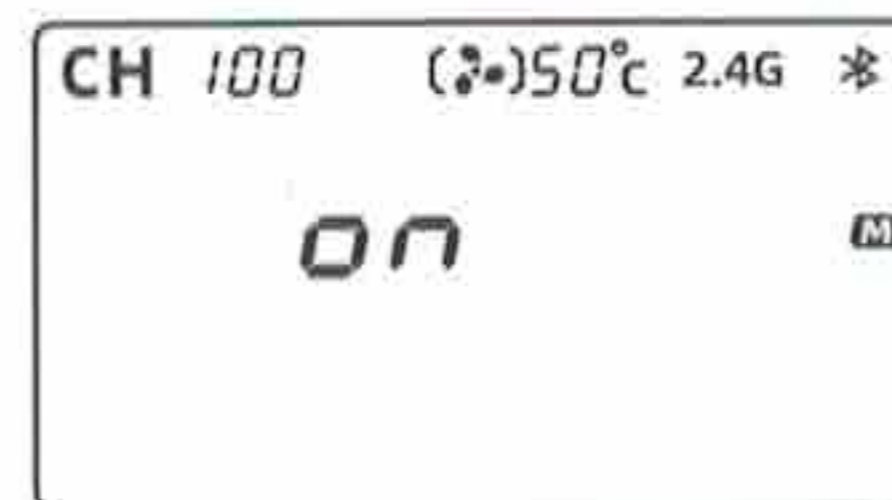

## 9. Install the soft light umbrella for use.

Insert the soft light umbrella through the umbrella hole, then tighten the umbrella hole fixing knob before use.  
(Note: The soft light umbrella needs to be purchase separately.)

